



KA8-B

(Glider)

MS:137

ASSEMBLY MANUAL

“Graphics and specifications may change without notice”.



Specifications:

Wing span ----- 118.1in (300cm).
Wing area ----- 899sq.in (58sq dm).
Weight ----- 6.2lbs (2.8kg).
Length ----- 57.1in (145cm).
Radio ----- 6 channels.
Servo ----- 4 MN48 mini servos.
3 servos flying skill level intermediate/advanced.

INTRODUCTION.

Thank you for choosing the **KA8-B** ARTF by SEAGULL MODELS. The **KA8-B** was designed with the sports trainer flyer in mind. It is a High-wing aeroplane which is easy to fly and quick to assemble. The airframe is conventionally built using balsa, plywood and veneer to make it stronger than the average ARTF, yet the design allows the aeroplane to be kept light. You will find that most of the work has been done for you already. The pushrods are pre-made to the correct lengths, the motor mount has been fitted and the hinges are pre-installed and pinned for security. Flying the **KA8-B** is simply a joy.

This instruction manual is designed to help you build a great flying aeroplane. Please read this manual thoroughly before starting assembly of your **KA8-B**. Use the parts listing below to identify all parts.

WARNING.

Please be aware that this aeroplane is not a toy and if it is assembled or used incorrectly it will cause injury to people or property. **WHEN YOU FLY THIS AEROPLANE YOU ASSUME ALL RISK & RESPONSIBILITY.**

If you are inexperienced with basic R/C flight we strongly recommend you contact your R/C supplier and join your local R/C Model Flying Club. R/C Model Flying Clubs offer a variety of training procedures designed to help the new pilot on his way to successful R/C flight. They will also be able to advise on any insurance and safety regulations that may apply.

ADDITIONAL ITEMS REQUIRED.

- 6 channels radio with 7 servos.
- Glow plug to suit engine.
- Propeller to suit engine.
- Protective foam rubber for radio system.
- Silicone fuel line.
- Stick-on weights for balance (If necessary).

TOOLS & SUPPLIES NEEDED.

- Thick cyanoacrylate glue.
- 30 minute epoxy.
- 5 minute epoxy.
- Hand or electric drill.
- Assorted drill bits.
- Modelling knife.
- Straight edge ruler.
- 2mm ball driver.
- Phillips head screwdriver.
- 220 grit sandpaper.
- 90° square or builder's triangle.
- Wire cutters.
- Masking tape & T-pins.
- Thread-lock.
- Paper towels.

PARTS LISTING.**FUSELAGE ASSEMBLY**

- 1) Fuselage.

WING ASSEMBLY

- 1) Right wing half with pre-installed aileron.
- 2) Left wing half with pre-installed aileron.

TAIL SECTION ASSEMBLY

- 1) Vertical stabilizer with pre-installed rudder.
- 2) Horizontal stabilizer with pre-installed elevator halves.

HINGING THE RUDDER .

Note: *The control surfaces, including the ailerons, elevators, and rudder, are prehinged with hinges installed, but the hinges are not glued in place. It is imperative that you properly adhere the hinges in place per the steps that follow using a high-quality thin C/A glue.*

- 1) Carefully remove the aileron from one of the wing panels. Note the position of the hinges.

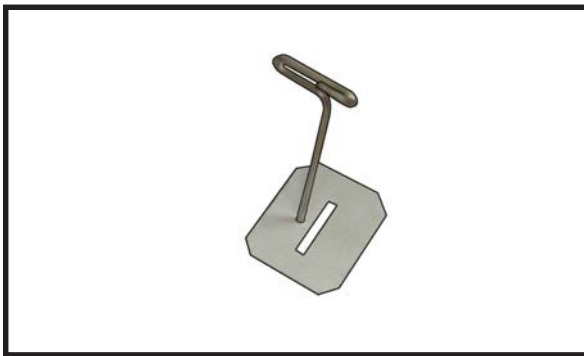

- 2) Remove each hinge from the wing panel and aileron and place a T-pin in the center of each hinge. Slide each hinge into the aileron until the T-pin is snug against the aileron. This will help ensure an equal amount of hinge is on either side of the hinge line when the aileron is mounted to the wing panel.

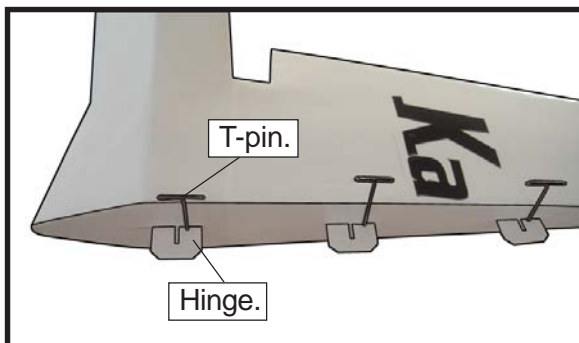

- 3) Slide the aileron on the wing panel until there is only a slight gap. The hinge is now centered on the wing panel and aileron. Remove the T-pins and snug the aileron against the wing panel. A gap of 1/64" or less should be maintained between the wing panel and aileron.

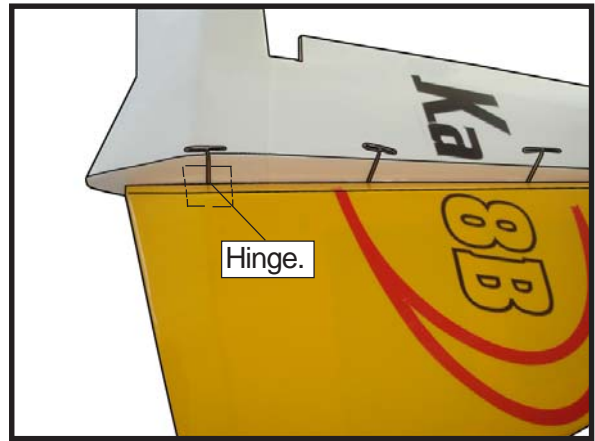

- 4) Deflect the aileron and completely saturate each hinge with thin C/A glue. The aileron's front surface should lightly contact the wing during this procedure. Ideally, when the hinges are glued in place, a 1/64" gap or less will be maintained throughout the length of the aileron to the wing panel hinge line.

Note: *The hinge is constructed of a special material that allows the C/A to wick or penetrate and distribute throughout the hinge, securely bonding it to the wood structure of the wing panel and aileron.*

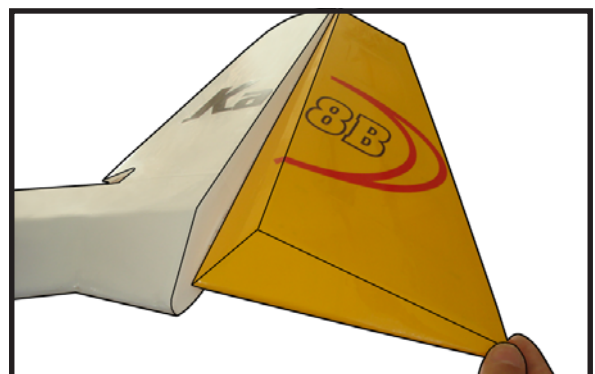



□ 5) Turn the wing panel over and deflect the aileron in the opposite direction from the opposite side. Apply thin C/A glue to each hinge, making sure that the C/A penetrates into both the aileron and wing panel.

□ 6) Using C/A remover/debonder and a paper towel, remove any excess C/A glue that may have accumulated on the wing or in the aileron hinge area.

□ 7) Repeat this process with the other wing panel, securely hinging the aileron in place.

□ 8) After both ailerons are securely hinged, firmly grasp the wing panel and aileron to make sure the hinges are securely glued and cannot be pulled out. Do this by carefully applying medium pressure, trying to separate the aileron from the wing panel. Use caution not to crush the wing structure.



Note: *Work the aileron up and down several times to “work in” the hinges and check for proper movement.*

HINGING THE ELEVATOR .

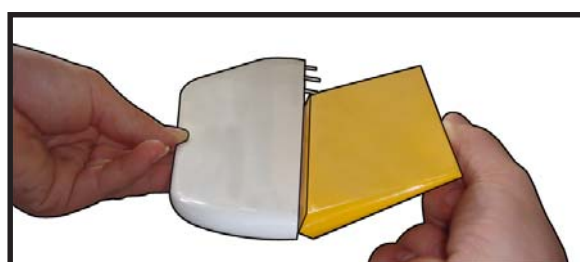
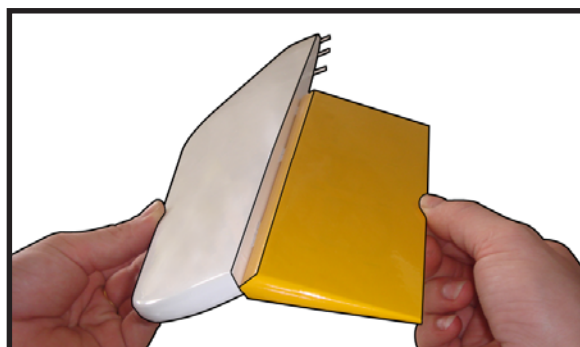
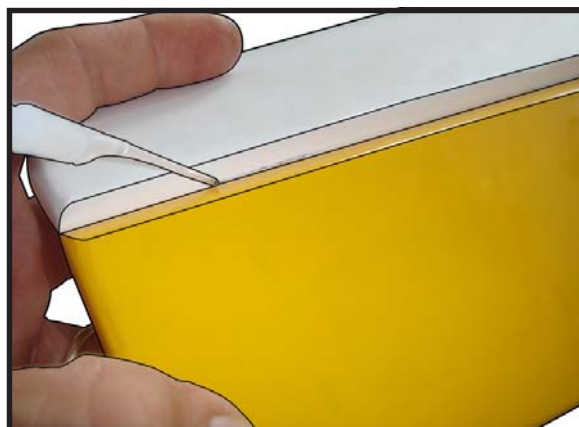
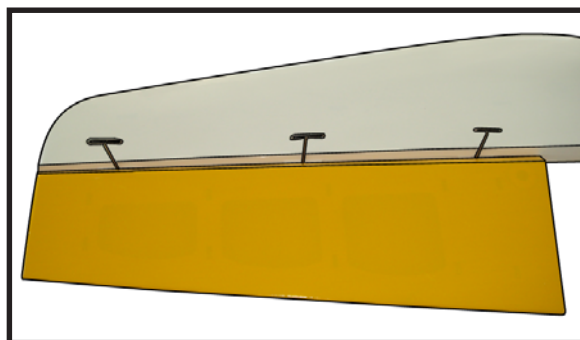
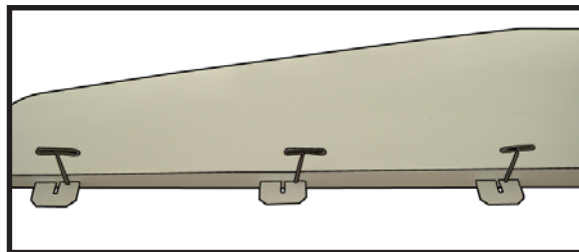

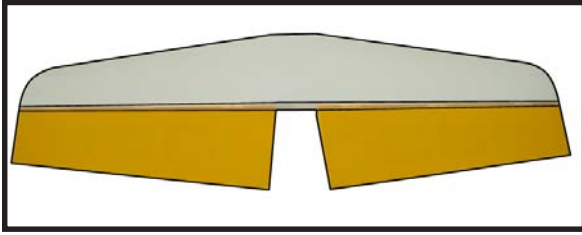

INSTALL THE AILERON CONTROL HORN .

1) Locate the hardware necessary to install the control horns for the ailerons.

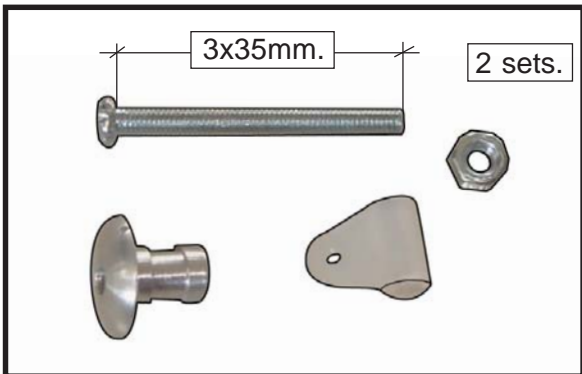

2) Position the control horn on the bottom of the aileron. You will see pre-drill hole 6mm for the horn mounting screw on the aileron.

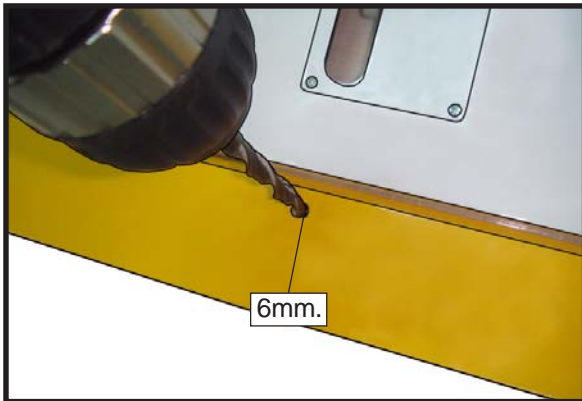

3) Place epoxy into hole. This will harden the threads and prevent the crews from pulling loose.

4) Thread a control horn end with aluminum washer, lock nut until the top edge of the end is 9mm from the vase of the horn as shown.

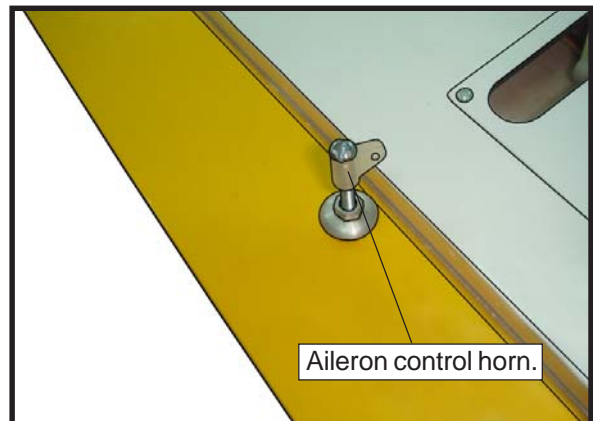
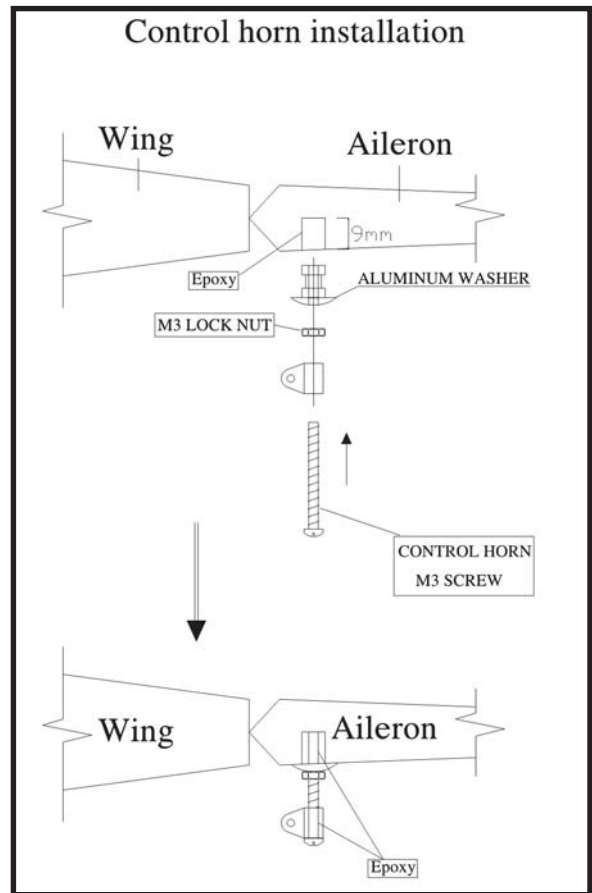

ELEVATOR CONTROL HORN INSTALLATION.

Install the elevator control horn using the same method as same as the aileron control horns.

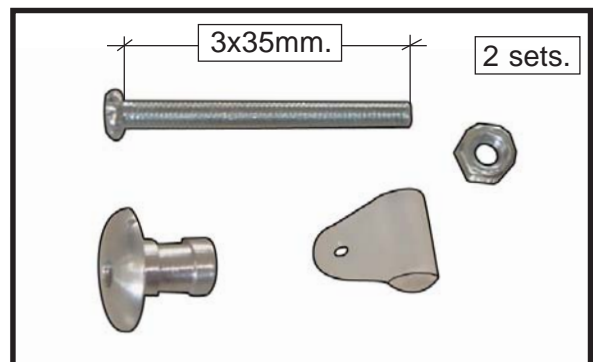

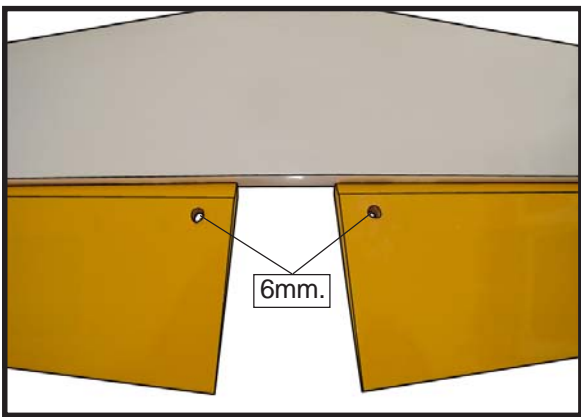
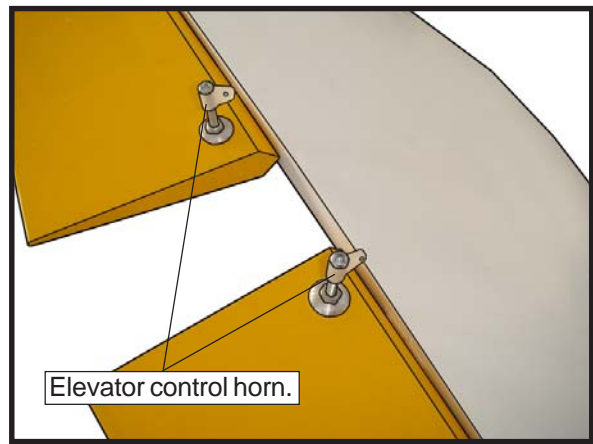
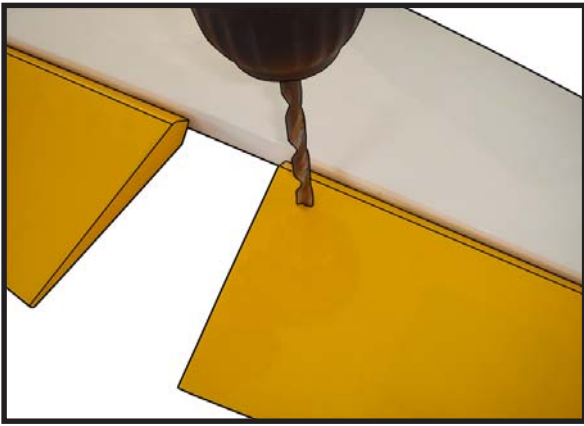

INSTALLING THE FUSELAGE SERVO.

! *Because the size of servos differ, you may need to adjust the size of the precut opening in the mount. The notch in the sides of the mount allow the servo lead to pass through.*

- 1) Install the rubber grommets and brass collets onto the throttle servo. Test fit the servo into the aileron servo mount.
- 2) Secure the servos with the screws provided with your radio system.

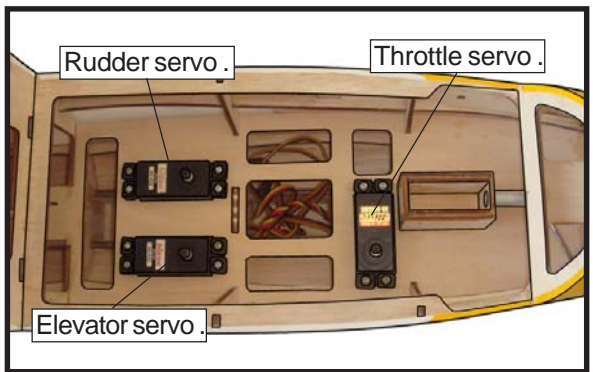
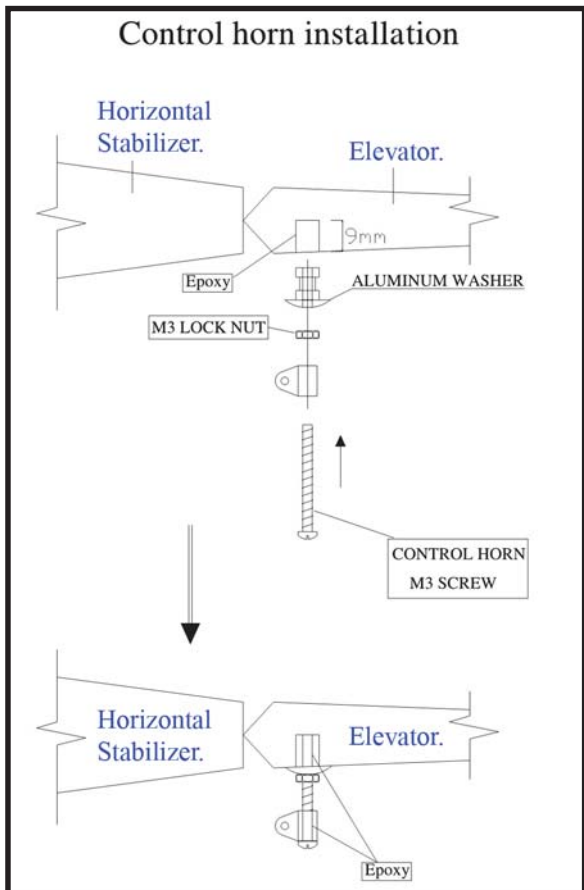

SERVO ARM INSTALLATION.

Install adjustable servo connector in the servo arm as same as picture below:

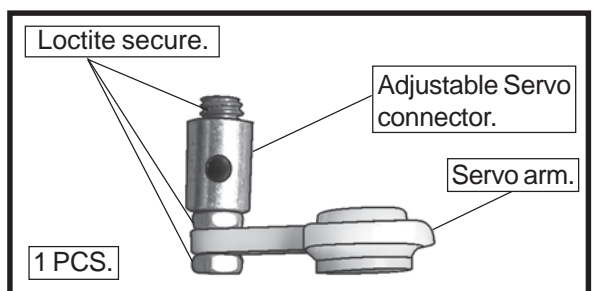

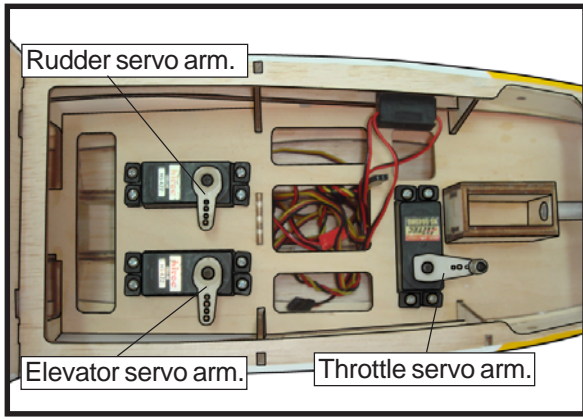

INSTALLING THE SWITCH.

Install the switch into the precut hole in the side of fuselage.

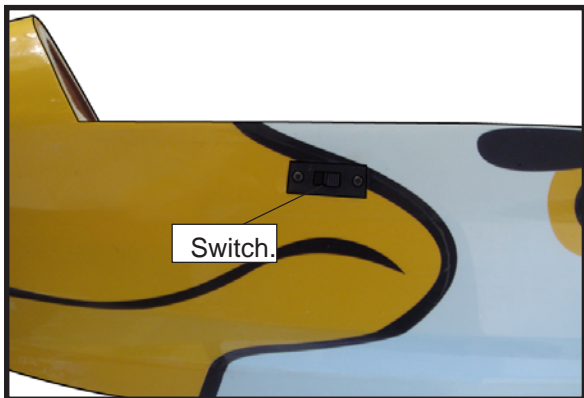
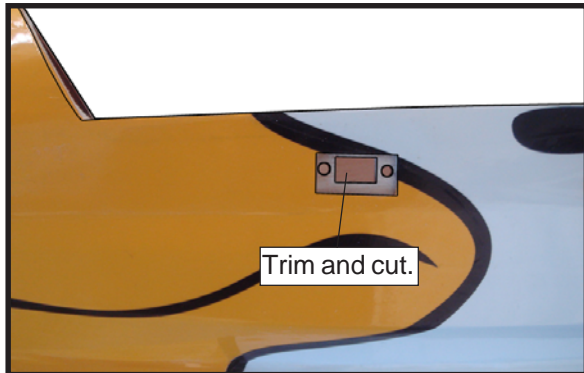

AILERON SERVO INSTALLATION.

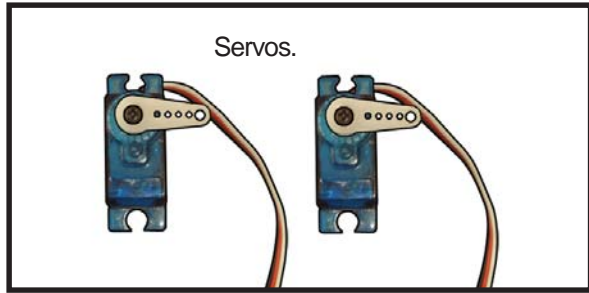

! *Because the size of servos differ, you may need to adjust the size of the precut opening in the mount. The notch in the sides of the mount allow the servo lead to pass through.*

2) Using a small weight (*Weighted fuel pick-up works well*) and string, feed the string through the wing as indicated.

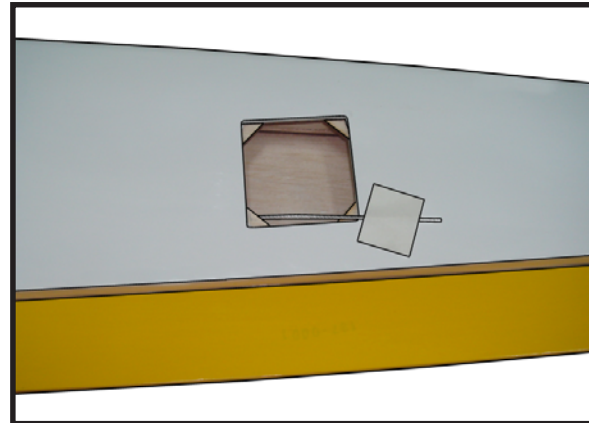
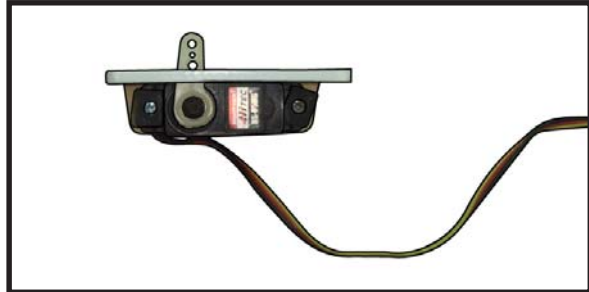

FLAP SERVO INSTALLATION.

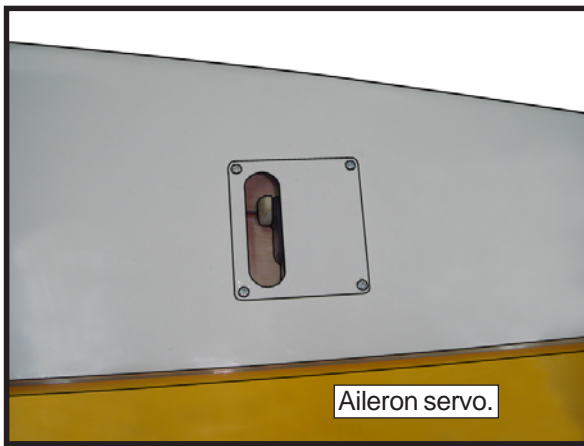
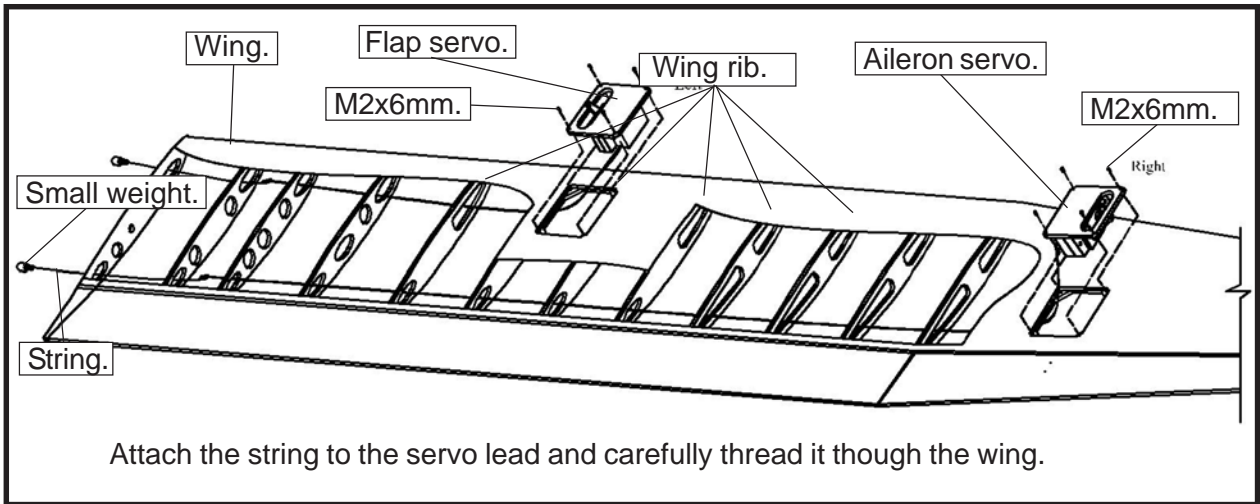
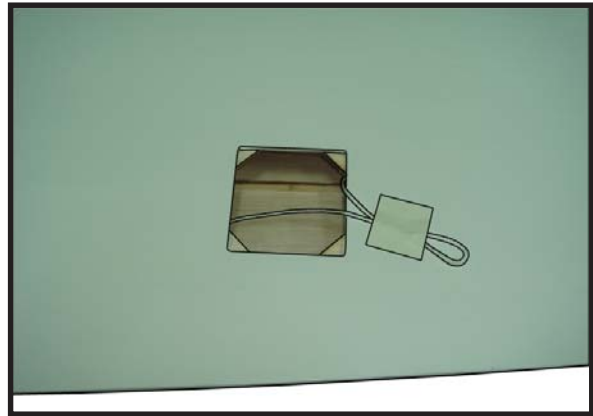
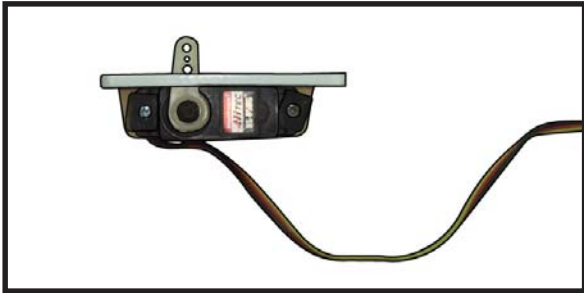

AILERON PUSHROD HORN INSTALLATION

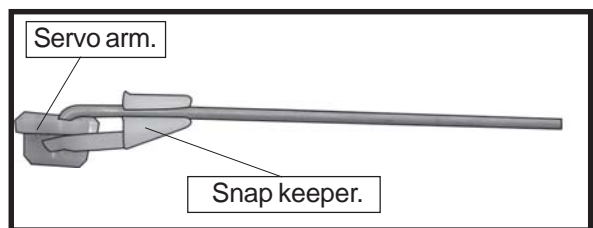
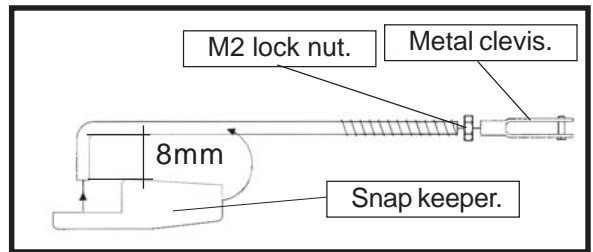
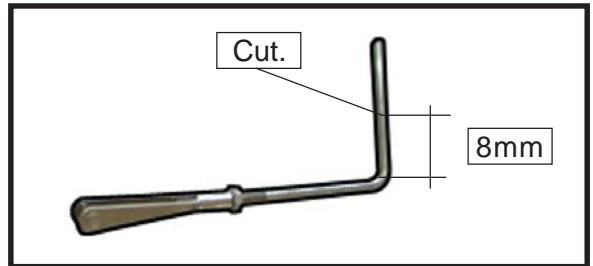

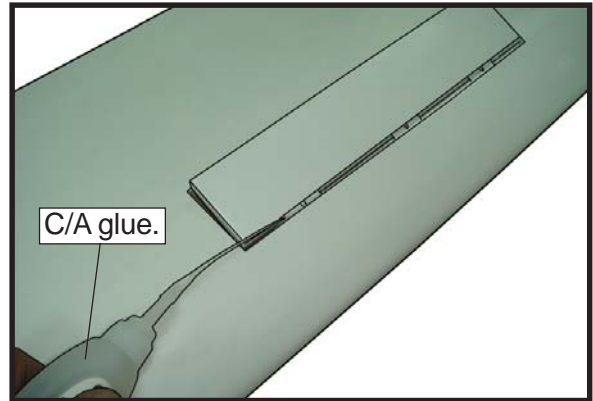
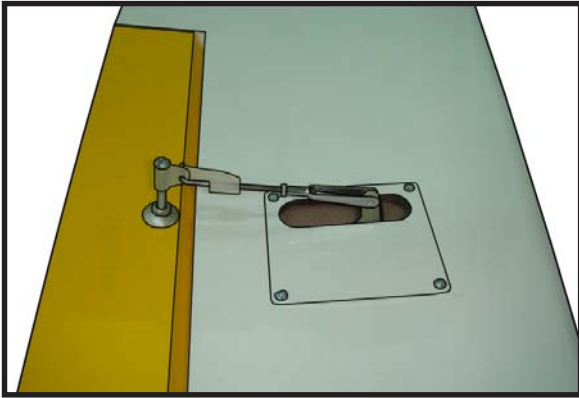

Repeat the procedure for the other aileron servo.

AIRBREAKES PUSHROD CONTROL HORN INSTALLATION.

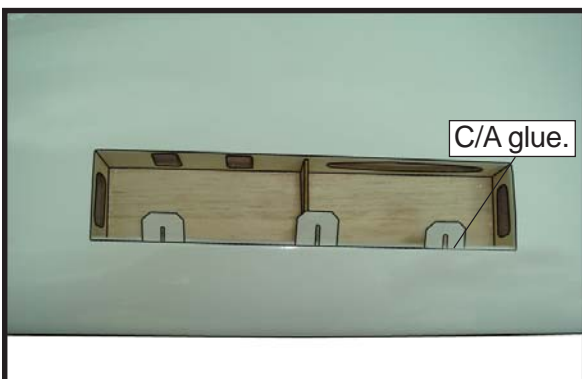
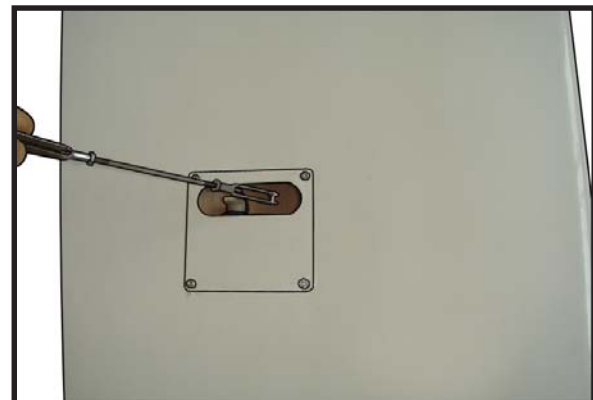
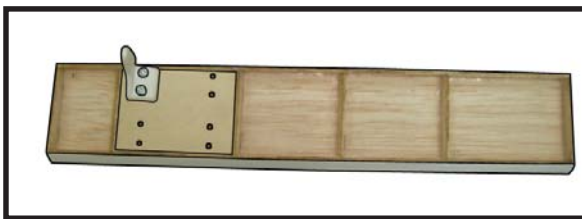
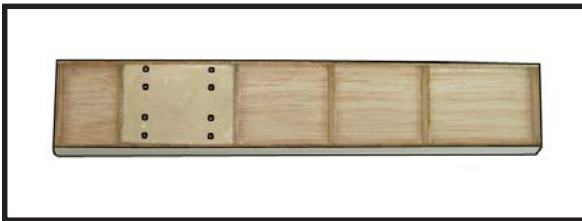
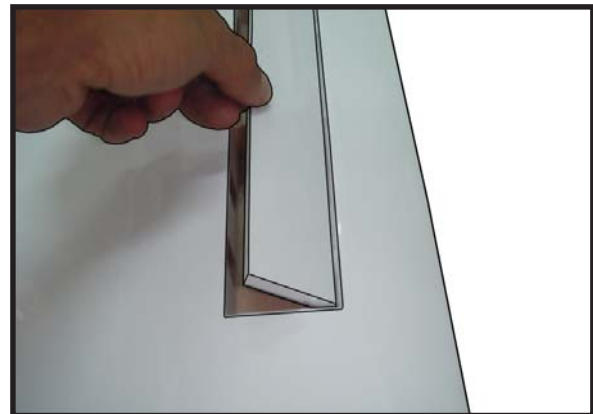
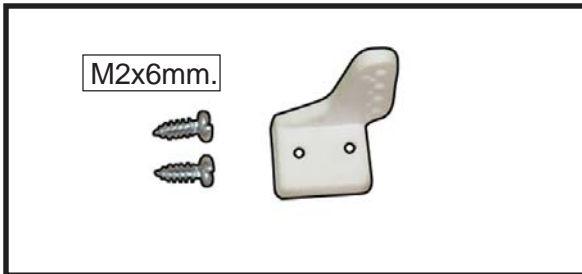

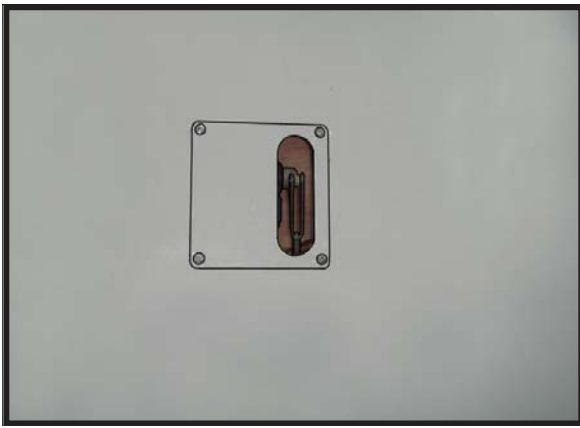

ELEVATOR PUSHROD INSTALLATION.

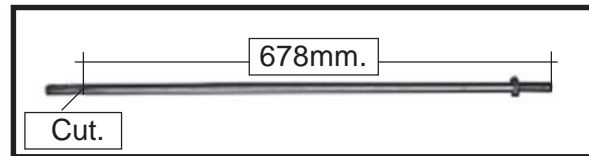
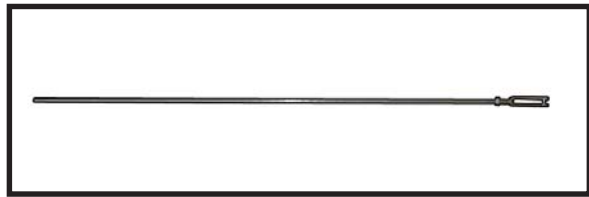

THE HORIZONTAL STABILIZER INSTALLATION.

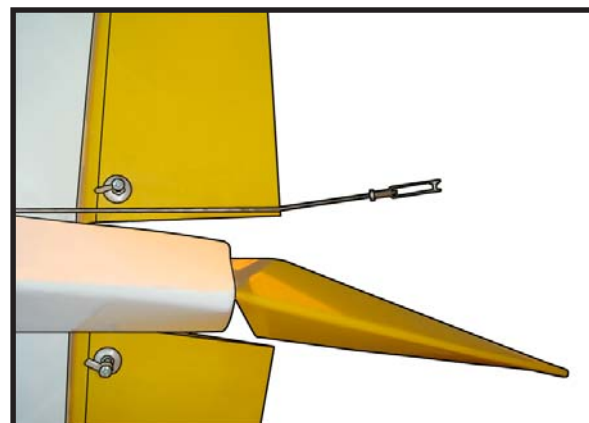
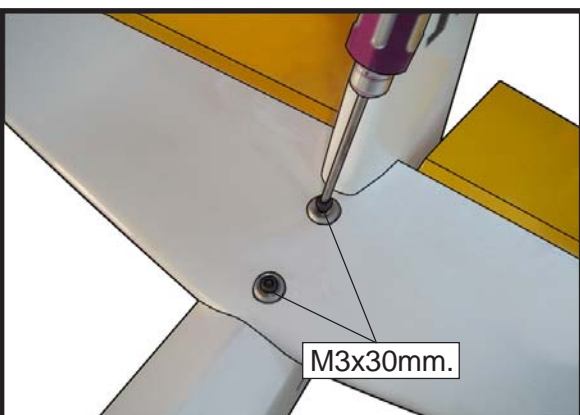
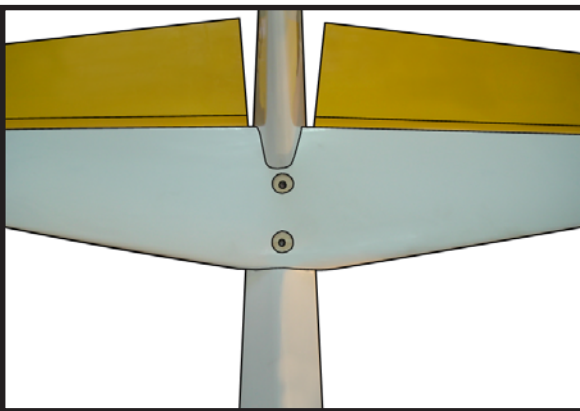
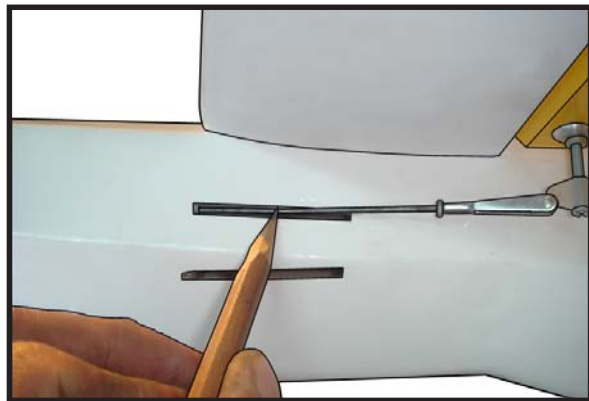

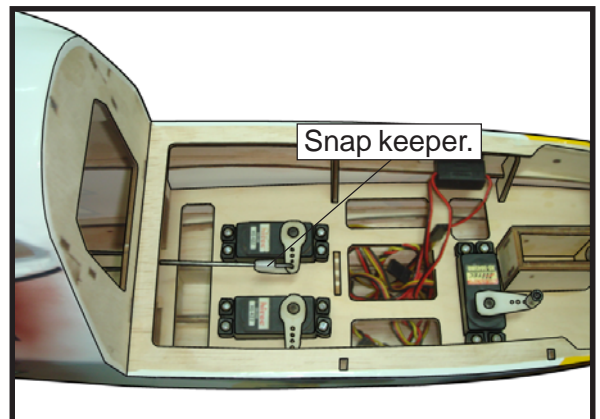
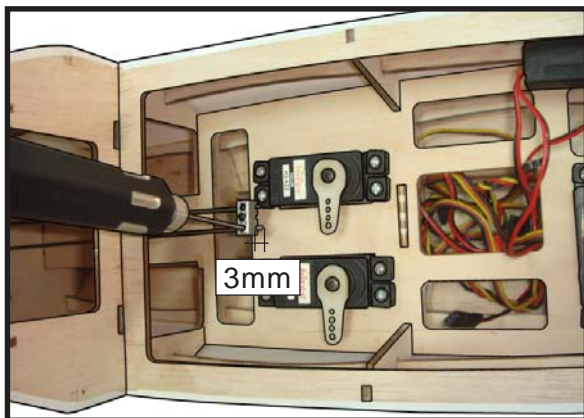
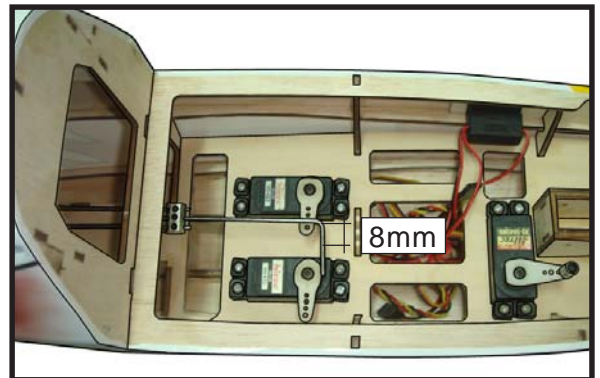
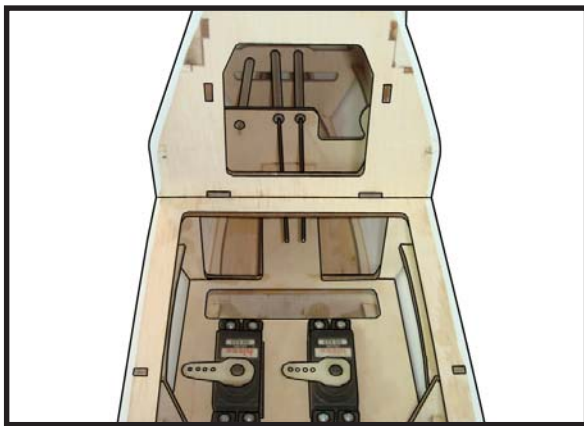
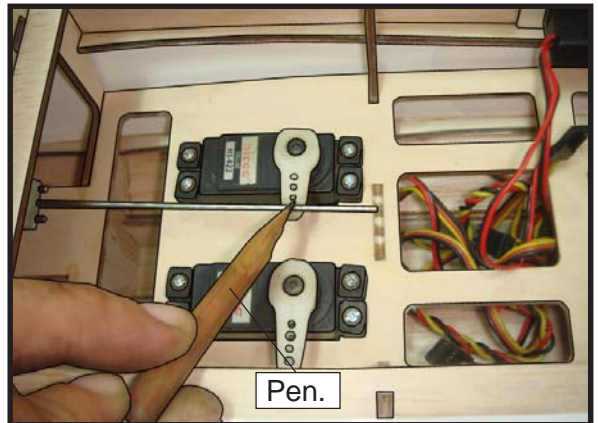
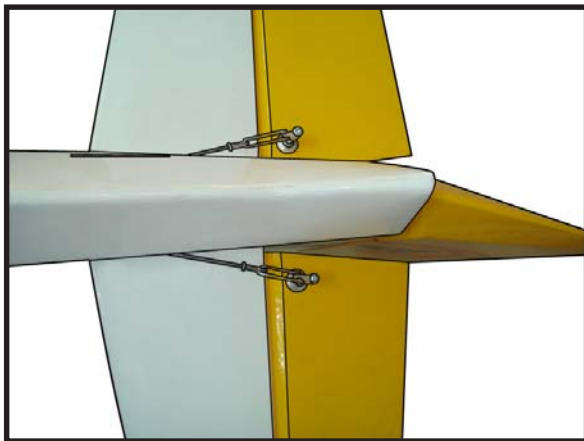
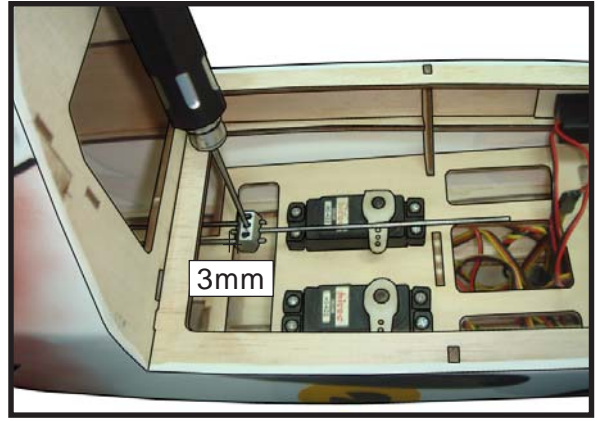
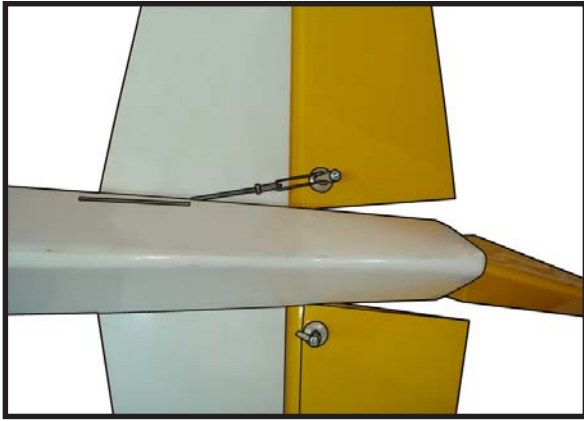

RUDDER PUSHROD.

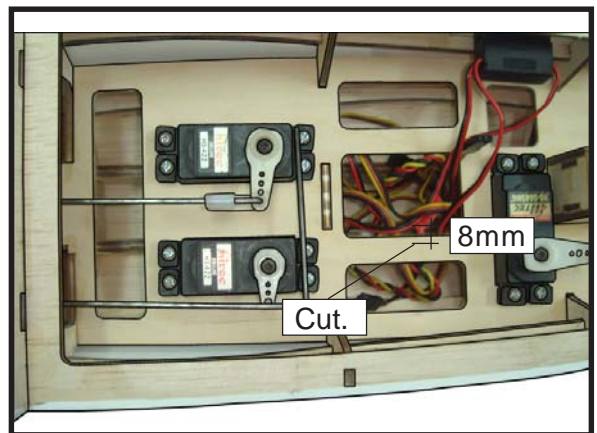
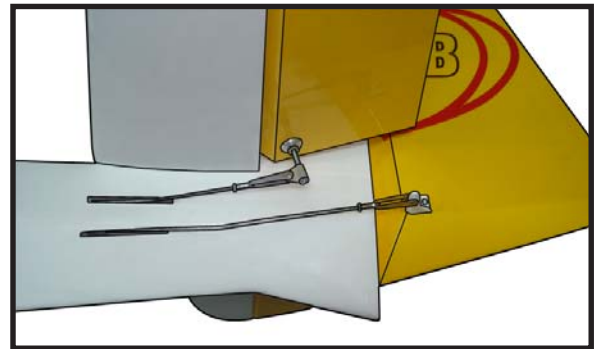
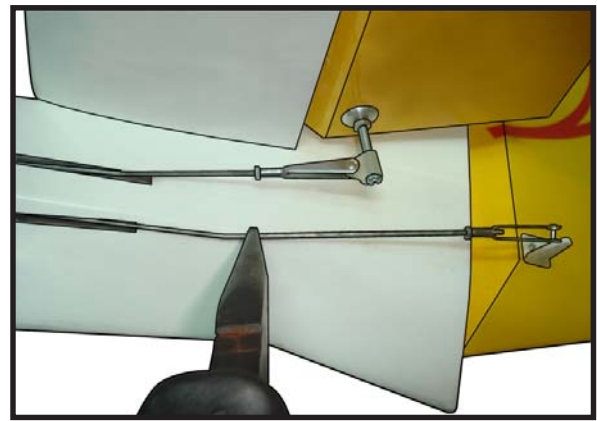
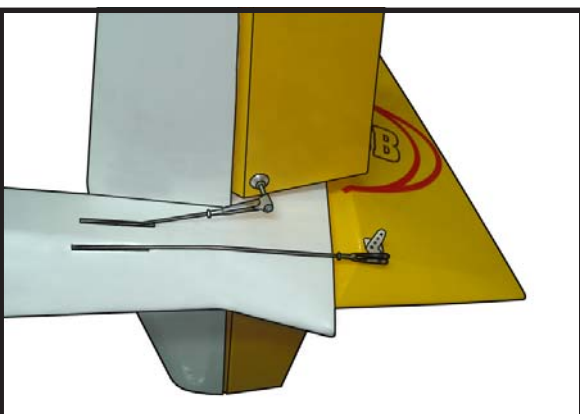
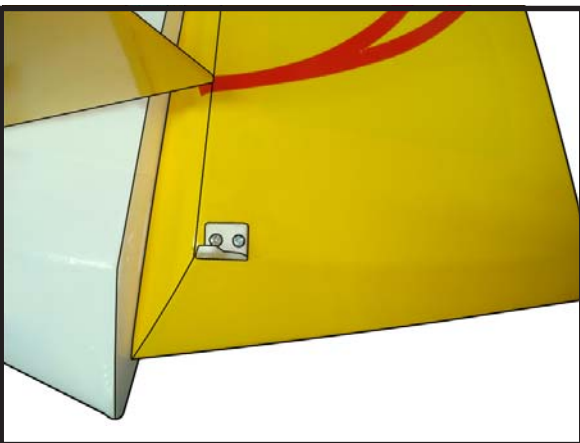
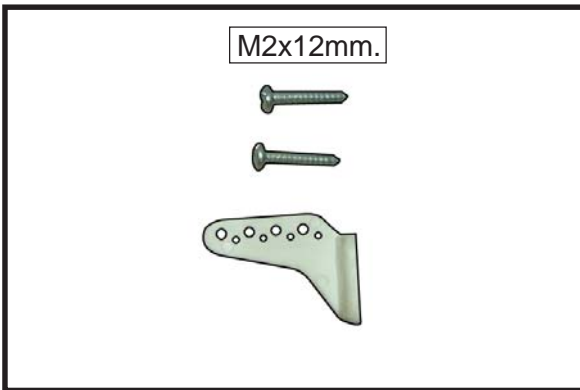
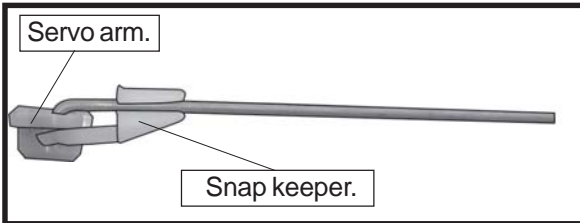
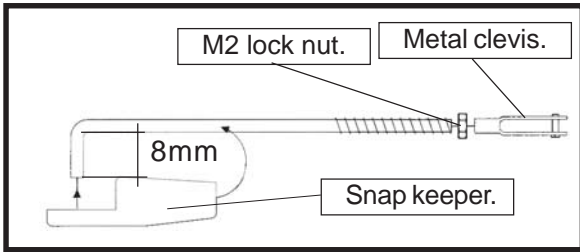

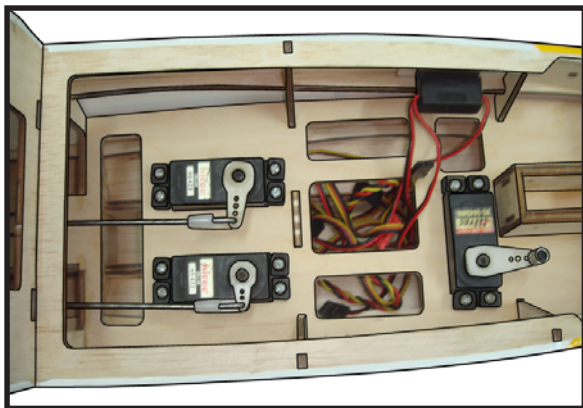

SERVO INSTALLATION.

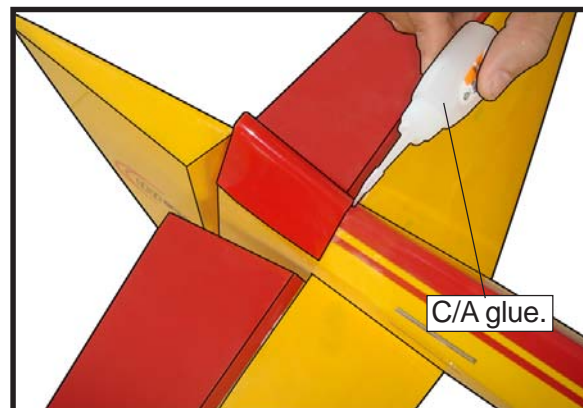
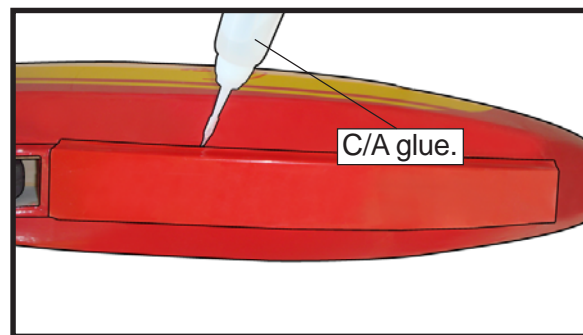
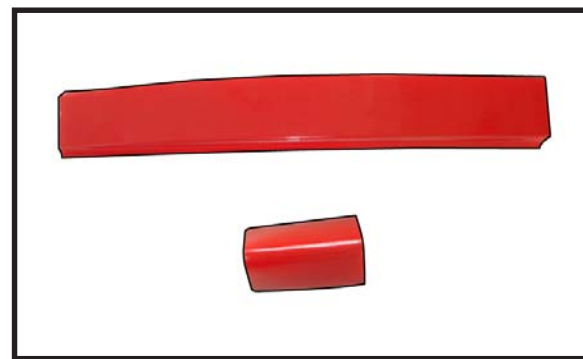
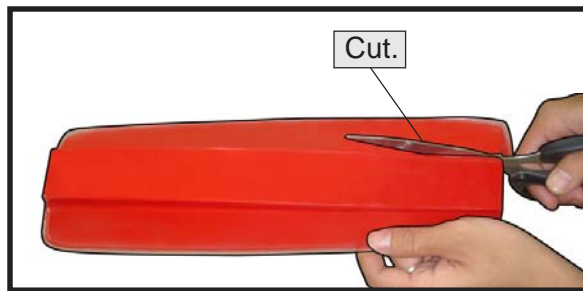
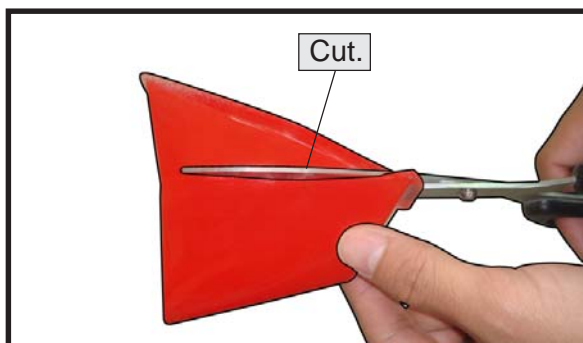
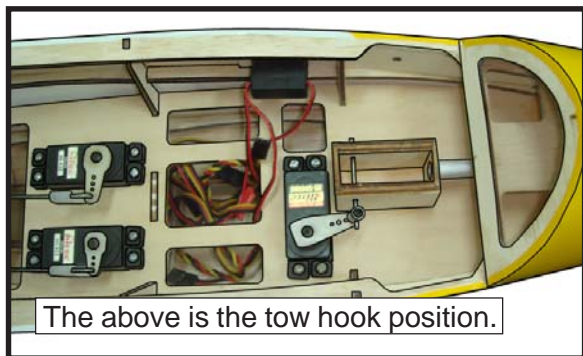
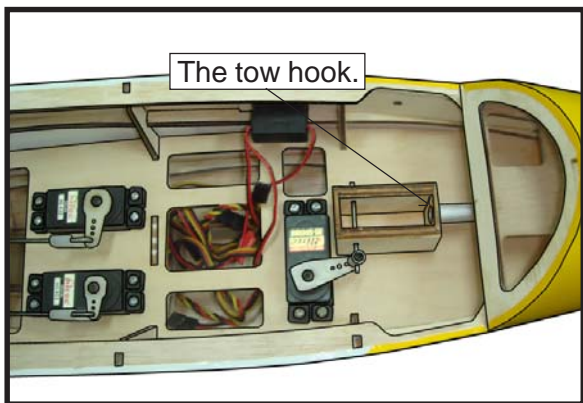

INSTALLING THE RECEIVER AND BATTERY.

- 1) Plug the five servo leads and the switch lead into the receiver. Plug the battery pack lead into the switch also.
- 2) Wrap the receiver and battery pack in the protective foam rubber to protect them from vibration.
- 3) Route the antenna in the antenna tube inside the fuselage and secure it to the bottom of fuselage using a plastic tape.

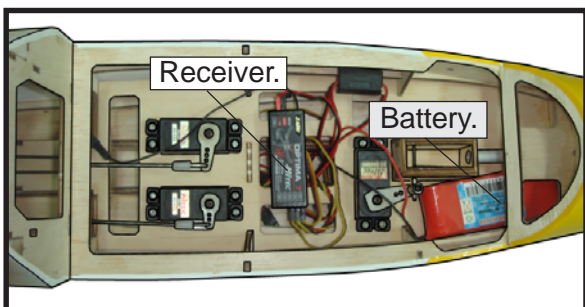
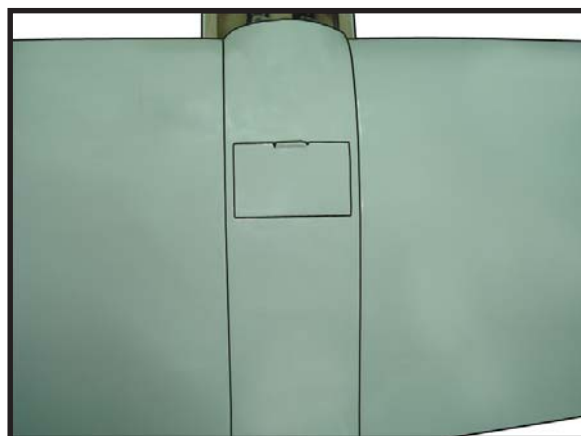
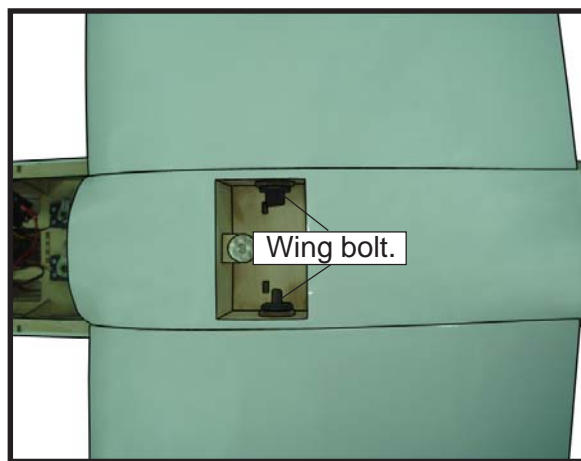
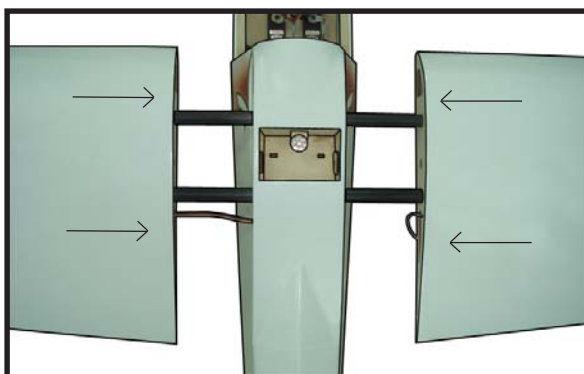
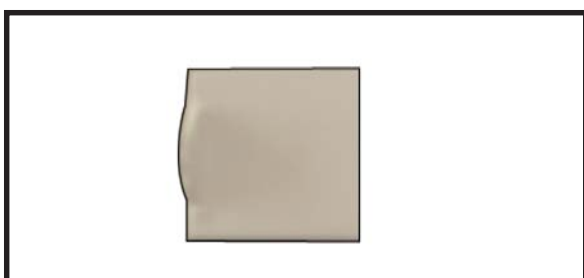
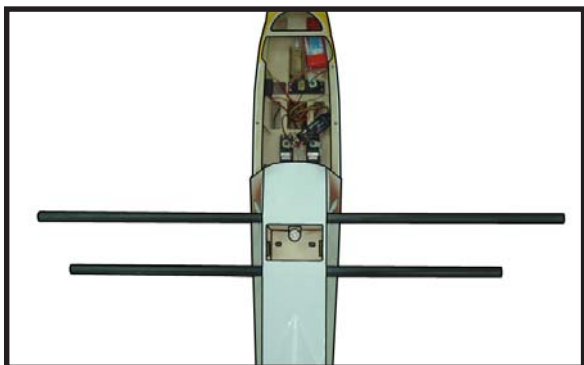
**ATTACHMENT WING -FUSELAGE.****BALANCING.**

- 1) It is critical that your airplane be balanced correctly. Improper balance will cause your plane to lose control and crash. THE CENTER OF GRAVITY IS LOCATED **60 MM** BACK FROM THE LEADING EDGE OF THE WING AT THE WING ROOT.
- 2) Mount the wing to the fuselage. Using a couple of pieces of masking tape, place them on the top side of the wing **60 mm** back from the leading edge of the wing at the wing root.
- 3) Turn the airplane upside down. Place your fingers on the masking tape and carefully lift the plane .

Accurately mark the balance point on the top of the wing on both sides of the fuselage. The balance point is located **60 mm** back from the leading edge of the wing at the wing root. This is the balance point at which your model should balance for your first flights. Later, you may wish to experiment by shifting the balance up to 10mm forward or back to change the flying characteristics. Moving the balance forward may improve the smoothness and arrow- like tracking, but it may then require more speed for take off and make it more difficult to slow down for landing. Moving the balance aft makes the model more agile with a lighter and snappier "feel". In any case, please start at the location we recommend .

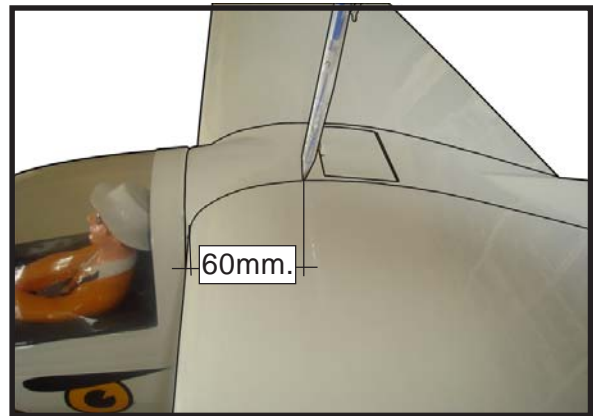

CONTROL THROWS.

Ailerons:	15mm up	15mm down.
Elevator:	15mm up	15mm down.
Rudder:	25mm right	25mm left.

With the wing attached to the fuselage, all parts of the model installed (ready to fly), and empty fuel tanks, hold the model at the marked balance point with the stabilizer level..

Lift the model. If the tail drops when you lift, the model is "tail heavy" and you must add weight* to the nose. If the nose drops, it is "nose heavy" and you must add weight* to the tail to balance.

*If possible, first attempt to balance the model by changing the position of the receiver battery and receiver. If you are unable to obtain good balance by doing so, then it will be necessary to add weight to the nose or tail to achieve the proper balance point.

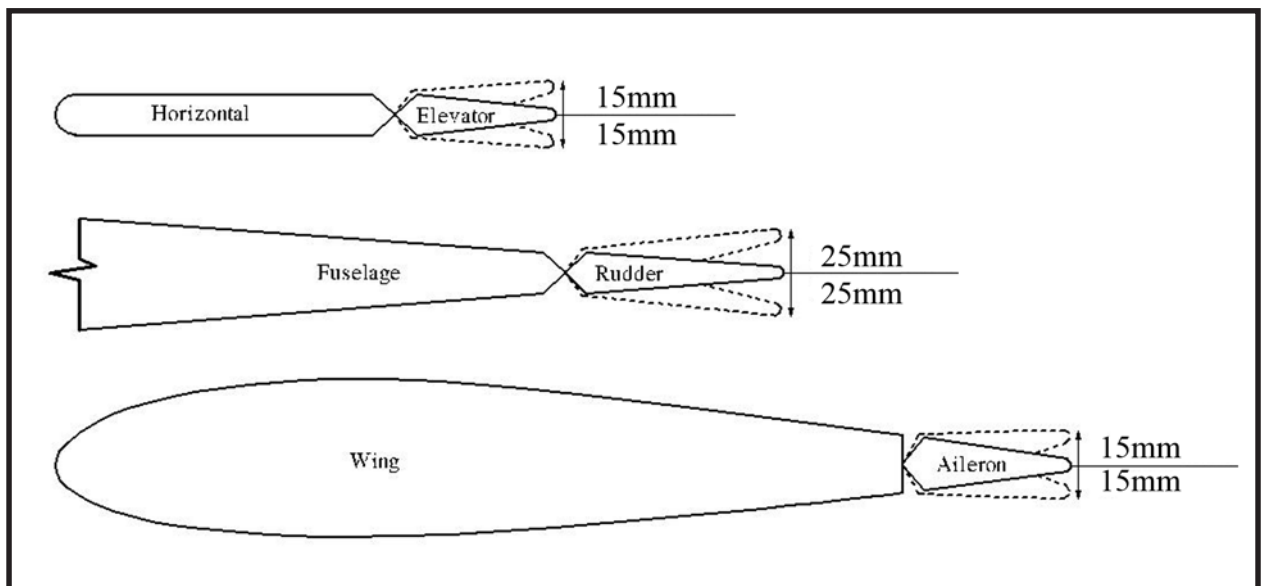

FLIGHT PREPARATION.

A) Check the operation and direction of the elevator, rudder, ailerons and throttle.

B) Plug in your radio system per the manufacture's instructions and turn every thing on.

C) Check the elevator first. Pull back on the elevator stick. The elevator halves should move up. If it they do not, flip the servo reversing switch on your transmitter to change the direction.

D) Check the rudder. Looking from behind the airplane, move the rudder stick to the right. The rudder should move to the right. If it does not, flip the servo reversing switch on your transmitter to change the direction.

E) Check the throttle. Moving the throttle stick forward should open the carburetor barrel. If it does not, flip the servo reversing switch on your transmitter to change the direction.

F) From behind the airplane, look at the aileron on the right wing half. Move the aileron stick to the right. The right aileron should move up and the other aileron should move down. If it does not, flip the servo reversing switch on your transmitter to change the direction.

PREFLIGHT CHECK.

1) Completely charge your transmitter and receiver batteries before your first day of flying.

2) Check every bolt and every glue joint in the **KA8-B** to ensure that everything is tight and well bonded.

3) Double check the balance of the airplane. Do this with the fuel tank empty.

4) Check the control surfaces. All should move in the correct direction and not bind in any way.

5) If your radio transmitter is equipped with dual rate switches double check that they are on the low rate setting for your first few flights.

6) Check to ensure the control surfaces are moving the proper amount for both low and high rate settings.

7) Check the receiver antenna. It should be fully extended and not coiled up inside the fuselage.

8) Properly balance the propeller. An out of balance propeller will cause excessive vibration which could lead to engine and/or airframe failure.

We wish you many safe and enjoyable flights with your KA8-B.